

## 800-DI14 digital input module

Expansion module for basic devices  
of the 800 series

User manual and technical data





#### Suitable base devices and number of module slots:

Suitable base devices / Number of free slots	Slot assignment of an 800-DI14 module on the basic device
UMG 801 (from FW 1.7.3) / 12 slots + 1 slot for an additional 800-DI14 module	1 slot
UMG 800 (from FW 1.7.1) / 12 slots + 1 slot for an additional 800-DI14 module	1 slot
For more information on module slot combinations and JanBus system limits, refer to the respective user manual for the base unit.	

*Tab. Suitable basic devices*

## 800-DI14 digital input module

(Suitable for basic devices of the 800 series)

Doc. no.: 2.053.097.1.c

Date: 04/2026

The German version is the original edition of the documentation

## Subject to technical alterations.

The contents of our documentation have been compiled with great care and reflect the current state of the information available to us. Nonetheless, we wish to point out that updates of this document are not always possible at the same time as technical refinements are implemented in our products. Please see our website under [www.janitza.com](http://www.janitza.com) for the current version.

Please see our website under [www.janitza.com](http://www.janitza.com) for the current version.

## Information about the GridVis software.

 Janipedia: [wiki.janitza.de](http://wiki.janitza.de)

 Tutorials: [youtube.com/@gridvis](https://youtube.com/@gridvis)

## Table of Contents

<b>1. Information on the devices and the user manual</b> .....	<b>8</b>
1.1 Disclaimer.....	8
1.2 Copyright notice.....	8
1.3 Technical changes.....	8
1.4 About this user manual.....	8
1.5 Defective device/disposal.....	9
<b>2. Safety</b> .....	<b>10</b>
2.1 Display of warning notices and safety information.....	10
2.2 Hazard levels.....	10
2.3 Product safety.....	10
2.4 Hazards when handling the device, components and modules.....	11
2.5 Electrically qualified personnel.....	12
2.6 Warranty in the event of damage.....	12
2.7 Safety information for handling current transformers.....	12
<b>3. Product description</b> .....	<b>14</b>
3.1 800-DI14 digital input module.....	14
3.2 Incoming goods inspection.....	14
3.3 Intended use.....	15
3.4 Overview of module functions.....	15
3.5 EU/UKCA Declaration of Conformity.....	16
3.6 FCC Declaration of Conformity.....	16
3.7 Transformers.....	16
3.8 Scope of delivery.....	16
3.9 Operating concept.....	17
3.10 GridVis network analysis software.....	17
<b>4. Mounting</b> .....	<b>18</b>
4.1 Mounting module.....	18
4.2 Checking the module's communication.....	21
4.3 Faulty module communication.....	21
<b>5. Connections/controls</b> .....	<b>22</b>

<b>6. Module markings – rating plate</b> .....	23
<b>7. Installation</b> .....	24
7.1 Digital inputs.....	24
7.2 Startup procedure/initialization.....	25
7.3 Connection example.....	25
7.4 Module identification / Diagnostics on the basic device.....	26
7.4.1 Entry Identify all modules.....	26
7.4.2 Entry Identify one module.....	27
7.4.3 Module identification - LED blink interval.....	27
<b>8. Module communication / PC connection</b> .....	28
8.1 Module communication.....	28
8.2 PC connection to the basic device with digital input module.....	28
8.2.1 Connection to a DHCP server and PC.....	28
8.2.2 Direct PC connection to the basic device with digital input module or your module series via the Ethernet interface.....	28
8.3 Module communication options.....	29
8.3.1 Module handling in the GridVis software.....	29
8.3.2 Basic device homepage.....	29
<b>9. Operation, display and button functions of the basic device with module</b> .....	30
9.1 Operation and button functions of the basic device with module 800-DI14.....	30
9.2 Module-relevant menu items of the basic device with one 800-DI14 module.....	30
<b>10. Digital input module 800-DI14 - Status messages</b> .....	31
<b>11. Module-relevant measuring displays (800-DI14 module only)</b> .....	32
<b>12. Device views</b> .....	34
<b>13. Technical data</b> .....	35
<b>14. Dismounting</b> .....	37

<b>15. Module exchange/error cases</b> .....	<b>38</b>
15.1 Module replacement.....	38
15.2 Modules - Error cases.....	39
<b>16. Service and maintenance</b> .....	<b>40</b>
16.1 Repair.....	40
16.2 Service.....	40
16.3 Device adjustment.....	40
16.4 Calibration interval.....	40
16.5 Firmware update.....	40
16.6 Procedure in the event of a malfunction.....	40
16.7 Reset to factory settings .....	40
16.8 Information on saving measured values and configuration data.....	41



## 1. Information on the devices and the user manual

### 1.1 Disclaimer

Compliance with the usage information for the devices (modules/components) is a prerequisite for safe operation and attaining the stated performance characteristics and product features.

Janitza electronics GmbH assumes no liability for bodily injury, material damage or financial losses which result from disregard of the usage information.

Ensure that the usage information for the products is legible and accessible.

### 1.2 Copyright notice

© 2023 - Janitza electronics GmbH - Lahnau. All rights reserved.

Any reproduction, processing, distribution or other use of this usage information, in whole or in part, is prohibited.

All trademarks and the rights arising from them are the property of the respective owners of these rights.

### 1.3 Technical changes

- Make sure that your device (modules/components) matches the user manual.
- This user manual applies to the 800-DI14 module. Separate validities and distinctions are marked.
- First make sure you have read and understood the usage information accompanying the product.
- Keep the usage information associated with the product available for the entire service life and pass it on to any possible subsequent users.
- Find out about device revisions and the associated modifications of the usage information associated with your product at [www.janitza.com](http://www.janitza.com).

### 1.4 About this user manual

If you have questions, suggestions or ideas for improvement of the user manual, please let us know via email at: [info@janitza.com](mailto:info@janitza.com).

---

#### **INFORMATION**

This user manual describes the 800-DI14 module for a suitable basic device (see „Tab. Suitable basic devices“ on p. 2) and provides information on operating the devices and modules.

Also consult the additional usage information relevant for this user manual, such as:

- the installation manual.
- the data sheet.
- the "Safety information" supplement.
- the supplement on mounting the modules.
- the usage information on the basic device and the integrated modules of your meter and module topology.

Moreover, the **GridVis** software has an “online help” feature.

---

#### **INFORMATION**

Our usage information uses the grammatical masculine form in a gender-neutral sense! This form always refers equally to women, men and diverse. In order to make the texts more readable, distinctions are not made. We ask for your understanding for these simplifications.

---

### 1.5 Defective device/disposal

Before sending **defective devices, modules or components** back to the manufacturer for testing:

- Contact the manufacturer's Support department.
- Send devices, modules or components complete with all accessories.
- When doing so, please bear the terms for transportation in mind.

---

#### **INFORMATION**

Please return defective or damaged devices, modules or components to Janitza electronics GmbH in accordance with the shipping instructions for air or road freight (complete with accessories).

Observe special regulations for devices with built-in batteries or rechargeable batteries!

---

Do not attempt to open or repair the device (the module, the component) on your own because otherwise all warranty claims become invalid!

For the **disposal** of the device (the module, the component), please observe national regulations! Dispose of individual parts, as applicable, depending on their composition and existing country-specific regulations, e.g. as

- Electronic waste,
- Batteries and rechargeable batteries,
- Plastics,
- Metals.

Engage a certified disposal company to handle scrapping as needed.

Information on "Service and maintenance" of your device can be found in Sect. "16. Service and maintenance" on p. 40.

## 2. Safety

The chapter on Safety contains information which must be observed to ensure your personal safety and avoid material damage.

### 2.1 Display of warning notices and safety information

The warning notices shown below

- are found throughout the usage information.
- can be found on the devices themselves.
- indicate potential risks and hazards,
- underscore aspects of the information provided that clarifies or simplifies procedures.



This additional symbol on the device (module/component) itself indicates an electrical hazard that can lead to severe injury or death.



This general warning symbol draws attention to a possible risk of injury. Be certain to observe all of the information listed under this symbol in order to avoid possible injury or even death.



### 2.2 Hazard levels

Warning and safety information is marked by a warning symbol, and the hazard levels are shown as follows, depending on the degree of hazard:

<b>DANGER</b>
Warns of an imminent danger which, if not avoided, results in serious or fatal injury.
<b>WARNING</b>
Warns of a potentially hazardous situation which, if not avoided, could result in serious injury or death.
<b>CAUTION</b>
Warns of an immediately hazardous situation which, if not avoided, can result in minor or moderate injury.
<b>ATTENTION</b>
Warns of an immediately hazardous situation which, if not avoided, can result in material or environmental damage.

### **INFORMATION**

Indicates procedures in which there is **no** hazard of personal injury or material damage.

### 2.3 Product safety

The devices, components and modules reflect current engineering practice and accepted safety standards, but hazards can arise nonetheless.

Observe the safety regulations and warning notices. If notices are disregarded, this can lead to personal injury and/or damage to the product.

Every type of tampering with or use of the devices and the modules,

- which goes beyond the mechanical, electrical or other operating limits can lead to personal injury and/or damage to the product;
- constitutes “misuse” and/or “negligence” under the product’s warranty and thus voids the warranty for any possible resulting damage.

Read and understand the user manual and the usage information on the basic device before installing, operating, maintaining and using the devices, components and modules.

Only operate the devices, components and modules when they are in perfect condition and in compliance with this user manual and the usage information that is included. Send defective devices, components or modules back to the manufacturer in compliance with proper transport conditions.

Retain the user manual throughout the service life of your product and keep it at hand for consultation.

When using the device, component or module, also observe the legal and safety regulations for your system that are applicable for the respective use case.

## 2.4 Hazards when handling the device, components and modules

When operating electric devices, components or modules, it is unavoidable for certain parts of these devices to conduct hazardous voltage. Consequently, severe bodily injury or material damage can occur if they are not handled properly.

Therefore, when handling our devices, components, or modules, always observe the following:

- do not exceed the limit values specified in the user manual and on the rating plate! This must also be observed during testing and commissioning!
- Take note of the safety and warning notices in all usage information that belongs to the device, components or modules!

### WARNING

**Disregarding the connection conditions of the Janitza measurement devices, modules or components can lead to injuries or even death or to material damage!**

- Do not use Janitza meters, modules or components for critical switching, control or protection applications where the safety of persons and property depends on this function.
- Do not carry out switching operations with the Janitza measurement devices, modules or components without prior inspection by your system manager with specialist knowledge! In particular, the safety of persons, material assets and the applicable standards must be taken into account!

### WARNING

**Risk of injury due to electrical current and voltage!**

Severe bodily injury or death can result! Therefore please abide by the following:

- **Do not touch bare, stripped wires or device inputs that are dangerous to touch on the devices, components and modules.**
- **Switch off your installation before commencing work! Secure it against being switched on! Check to be sure it is de-energized! Ground and short circuit! Cover or block off adjacent live parts!**
- **During operation and troubleshooting (especially with DIN rail devices), check the environment for dangerous voltages and switch these off if necessary!**
- **Wear protective clothing and protective equipment in accordance with applicable guidelines when working on electrical systems!**
- **Before making connections, ground the device / component / module by means of the ground wire connection, if present!**
- **Do not touching bare or stripped leads that are energized! Equip stranded conductors with wire ferrules!**
- **Hazardous voltages can be present in all circuitry parts that are connected to the power supply.**
- **Protect wires, cables and devices with a suitable line circuit breaker/fuse!**
- **Never switch off, remove or tamper with safety devices!**
- **There can still be hazardous voltages present in the device or in the component (module) even after it has been disconnected from the supply voltage (capacitor storage).**
- **Only connect screw terminals with the same number of poles and design!**
- **Do not exceed the limit values specified in the user manual and on the rating plate! This must also be observed during testing and commissioning.**
- **Take note of the safety and warning notices in the usage information that belongs to the device, components or modules!**

## 2.5 Electrically qualified personnel

To avoid bodily injury and material damage, only electrically qualified personnel are permitted to work on the devices and their components, modules, assemblies, systems and current circuits who have knowledge of:

- The national and international accident prevention regulations.
- Safety technology standards.
- Installation, commissioning, operation, disconnection, grounding and marking of electrical equipment.
- the requirements concerning personal protective equipment.

Electrically qualified persons within the scope of the technical safety information of all usage information associated with the device and its components (modules) are persons who can furnish proof of qualification as an electrically skilled person.

### WARNING

#### **Warning against unauthorized manipulation or improper use of the device or its components (modules)!**

Opening, dismantling or unauthorized manipulation of the device and its components (modules) which goes beyond the mechanical, electrical or other operating limits indicated can lead to material damage or injury, up to and including death.

- **Only electrically qualified personnel are permitted to work on the devices and their components (modules), assemblies, systems and current circuits.**
- **Always use your device or component (module) only in the manner described in the associated documentation.**
- **If there is discernible damage, send the device or the component (module) back to the manufacturer!**

## 2.6 Warranty in the event of damage

Any unauthorized tampering with or use of the device, component or module constitutes "misuse" and/or "negligence" under the product's warranty and thus voids the warranty for any possible resulting damage. Note in this regard Sect. "3.3 Intended use" on p. 15.

## 2.7 Safety information for handling current transformers

The field of transformer technology groups the totality of all devices that perform the function of a current, voltage or measuring transformer together as **sensors**.

In the usage information for our devices, modules and components, the terms **current transformer**, **voltage transformer** or **transformer** all refer to **sensors**.

A further distinction is made by the terms **CT (current transformer)** and **LP-CT (low-power current transformer)**:

The term "current transformer" is used for special transformers for the primary-proportional conversion of currents of large magnitudes to directly measurable, smaller current values.

In contrast, the term "LP current transformer" (low-power current transformer) is used for special transformers for the primary-proportional conversion of currents of large magnitudes to directly measurable, smaller voltage values (low power).

**Current transformers** and **LP current transformers** provide safe galvanic isolation between the primary circuit and the measurement circuit due to their design and their physical operating principle. For Janitza measurement devices, modules and components, use only "**transformers for measuring purposes**" that are suitable for the energy monitoring of your system! Observe the corresponding warning notices!

Basic devices use only the term "**current transformer**" in the display for the configuration of both **current transformers** and **LP current transformers**.

**⚠ CAUTION****Risk of injury or damage to the meter due to high measured currents/measured voltages at the connections of the current transformers!**

High measurement currents can cause temperatures of up to 80 °C (176 °F) on the connections of the current transformers

- **Use wiring that is designed for an operating temperature of at least 80 °C (176 °F)!**
- **Only use current transformers with basic insulation to IEC 61010-1:2010!**
- **Make sure that screw terminals for the current transformer connection on the device are adequately tightened!**
- **Comply with the information and provisions in the documentation of your current transformers!**
- **Ground connections present on the secondary windings of the current transformers must be connected to ground!**
- **The current transformers can be hot even after the power supply has been switched off. Allow the connections of the current transformers and the connecting cables to cool down before touching them!**

**⚠ CAUTION****Risk of injury or damage to the basic device (module) and/or your system due to a short circuit!**

Inadequate insulation at the current measurement inputs of the modules with respect to the supply circuits of the basic device can cause dangerous voltages at the measurement input or damage to your device (module)/system.

- **Ensure reinforced or double insulation with respect to the supply circuits!**

### 3. Product description

#### 3.1 800-DI14 digital input module

The 800-DI14 digital input module extends the range of functions of a basic device by 14 digital inputs and is suitable for basic devices from the 800 series (see „Tab. Suitable basic devices“ on p. 2).

Basic devices recognize an input signal at the digital input of the 800-DI14 module if

- A voltage of at least 18 V and at most 28 V DC (typically at 4 mA) is present.
- A current of at least 0.5 mA and at most 6 mA flows.

With voltages from 0 to 5 V and currents of less than 0.5 mA, no input signal is recognized.

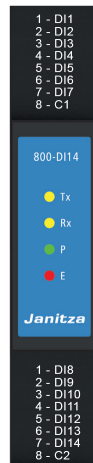

Fig.: 800-DI14 module  
(view without terminals)

#### **i** INFORMATION

When setting up your meter and module topology, note the following:

- Do not exceed the permitted number of modules on a basic device (see usage information for the basic device and „Tab. Suitable basic devices“ on p. 2).
- Check that the scope of delivery of the module includes the appropriate bus connector (JanBus interface) for connection to the basic device.
- In addition to the digital input module, also read and understand the usage information for the basic device.
- Do not exceed the maximum bus length of the JanBus (see Sect. “13. Technical data” on p. 35).

#### 3.2 Incoming goods inspection

The prerequisites for trouble-free and safe operation of the module include proper transport, storage, setup and assembly, as well as proper operation and maintenance.

Exercise due caution when unpacking and packing the device, do not use force and only use suitable tools. Check the following:

- the module by performing a visual inspection to ensure flawless mechanical condition.
- the scope of delivery (see Sect. “3.8 Scope of delivery” on p. 16) for completeness before beginning with assembly and installation.

If it must be assumed that safe operation of your basic device with module is not possible:

1. **Switch off the power to your system (your device)!**
2. **Secure it against being switched back on!**
3. **Check to be sure it is de-energized!**
4. **Ground and short circuit the system (device)!**
5. **Cover or block off adjacent live parts!**

Safe operation is impossible, if, for example, the basic device with module:

- Has visible damage,
- No longer functions despite an intact power supply,
- Was subjected to extended periods of unfavorable conditions (e.g. storage outside of the permissible climate thresholds without adjustment to the room climate, condensation, etc.) or transport stress (e.g. falling from an elevated position, even without visible external damage, etc.).

#### **ATTENTION**

**Improper handling may cause damage to the module and result in material damage!**

The contacts of the bus connectors (Janbus interface) can bend or break off and destroy the bus connector.

- **Never touch or manipulate the contacts of the bus connector!**
- **Never force the bus connector into the module! Please note Sect. “4. Mounting” on p. 18 in this regard.**
- **When handling, transporting and storing the module, protect the contacts of the bus connector!**

### 3.3 Intended use

The module / component

- is only for use in the industrial sector.
- is intended as an expansion module for a basic device (see „Tab. Suitable basic devices“ on p. 2) in switchboard cabinets and small distribution boards.
- must only be mounted with a basic device that is disconnected from the power supply (see Sect. “4. Mounting” on p. 18).

---

#### **INFORMATION**

**More information on certain functions of the basic device with modules can be found in the usage information of the basic device.**

---

The basic device and the modules are **not** designed for installation:

- In vehicles! Use of the basic device with modules in non-stationary equipment is considered an exceptional environmental condition and is only permissible by special agreement.
- In environments with harmful oils, acids, gases, vapors, dusts, radiation, etc.
- In potentially explosive environments.

### 3.4 Overview of module functions

Functions of the 800-DI14 module:

- 14 additional digital inputs.
- Detects an input signal at  $U = \text{min. } 18 \text{ V}$  and  $\text{max. } 28 \text{ V DC}$  (typically at 4 mA) or  $I = \text{min. } 0.5 \text{ mA}$  and  $\text{max. } 6 \text{ mA}$ .

### 3.5 EU/UKCA Declaration of Conformity

Please see the EU/UKCA declarations of conformity posted at [www.janitza.com](http://www.janitza.com) for the laws, standards and directives applied by Janitza electronics GmbH for the devices. The EU/UKCA conformity of the device permits the marking CE/UKCA.

### 3.6 FCC Declaration of Conformity



The device

- complies with Part 15 of the FCC Rules for Class B digital devices (limits to protect against harmful interference in a residential installation).
- generates, uses and can radiate high-frequency energy
- can cause harmful interference to radio communications if not installed and used properly. There is no guarantee that interference will not occur in a particular installation.

If there is radio or television reception interference, which can be determined by turning the device on and off, proceed as follows:

- Align or reposition the receiving antenna.
- Increase the distance between the device and the radio/television receiver.
- Connect the device and the radio/television receiver in different circuits.
- if necessary, contact Janitza support or a radio/television technician.

*Code of Federal Regulations, Title 47, Part 15, Subpart B - Unintentional Radiators.*

### 3.7 Transformers

It is not permitted to use the outputs of Janitza measurement devices, components and modules for switching protective devices or protective relays! Use only "Current transformers for measuring purposes" for Janitza measurement devices, components and modules!

### 3.8 Scope of delivery

Quantity	Part. no.	Designation
1	5231214	800-DI14 module (digital input module)
1	5231264	Accessory pack
1	3303886	Installation manual (DE/EN)
1	3303342	"Safety Information" supplement

*Tab. Scope of delivery for 800-DI14 digital input module*

### **i** INFORMATION

- The modules are supplied with the necessary screw terminals and bus connectors (JanBus interface) for connection to a basic device or other modules (accessory pack).
- Please refer to the delivery note for all options and design variants supplied.
- You can use the GridVis network analysis software available at [www.janitza.com](http://www.janitza.com) to configure the basic device with modules and read out data for analysis (prerequisite: PC connection to your basic device).

### 3.9 Operating concept

Options to configure the basic device with digital input module or to read measured values:

- Display and buttons on the basic device (user interface).
- GridVis network analysis software.
- RS-485 interface or Ethernet interface.

The modules can be used to realize meter and module topologies with a flexible arrangement of the DIN rails. For the operation of the devices, components and modules integrated in your meter and module topology, please refer to the respective additional usage information.

---

#### **INFORMATION**

This user manual describes modules and provides information on operating the modules via a basic device.

Please refer to the user manual for the basic device for information on operating, configuring and reading out expansion modules.

The GridVis software has an online help with tutorials.

**A list of parameters and Modbus addresses with data on your basic device with module is available for you as a download at [www.janitza.com](http://www.janitza.com).**

---

### 3.10 GridVis network analysis software

With the GridVis software, you have the perfect tool for programming, reading out and visualizing measurement data (download at [www.janitza.com](http://www.janitza.com)).

#### **Performance characteristics of the GridVis software**

- Configuration of the basic device and the modules of your meter and module topology.
- Graphic display of measured values.
- Online help and tutorials.

#### **Connections to the PC (GridVis software)**

Information on connections for communication between the PC and the basic device (with modules) can be found in the usage information for the basic device.

## 4. Mounting

### 4.1 Mounting module

#### ⚠ CAUTION

**Disregard of the installation instructions may cause property damage or personal injury!**

Disregard of the installation instructions may cause damage to your basic device with module or destroy it and/or may also result in personal injury.

- **In addition to the installation instructions for your module, also observe the installation instructions for your basic device, in particular the safety and warning information.**
- **Before installing modules**
  - **Disconnect the supply of power to the system!**
  - **Secure it against being switched on!**
  - **Check to be sure it is de-energized!**
  - **Ground and short circuit!**
  - **Cover or block off adjacent live parts!**
- **Operate the basic device that belongs to the 800-DI14 module only with a supply voltage of 24 V! Observe the technical specifications in the usage information for the basic device.**
- **Provide adequate air circulation in your installation environment and cooling, as needed, when the ambient temperatures are high.**
- **Return defective modules to Janitza electronics GmbH in accordance with the shipping instructions for air or road freight (complete with accessories).**
- **All usage information is available for download at [www.janitza.com](http://www.janitza.com).**

#### **i** INFORMATION

System limits:

- The maximum bus length (JanBus) for the setup of measurement device and module topologies can be found in the "Technical data".
- If necessary, observe the installation manual for transfer modules when setting up decentralized measuring concepts.
- Before mounting, please check the number of suitable modules for your measurement device and module topology based on the respective usage information.
- When installing the device/module, ensure that there is sufficient space in the installation environment. Please also note the size of the connection terminals used!

The scope of delivery of the 800-DI14 module can be found in Sect. "3.8 Scope of delivery" on p. 16. More information on certain functions of the basic device with modules can be found in the usage information of the basic device.

Observe the installation instructions for your basic device (e.g. check bus connector installation!) and mount the 800-DI14 module with the system de-energized as follows:

1. Press in the open bottom bolts on the rear of the module.

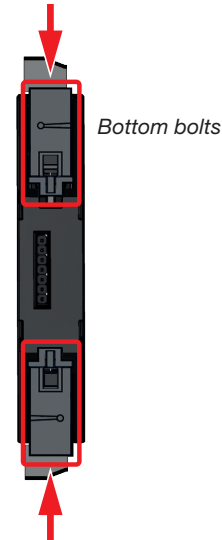

Fig.: Module rear view

#### **i** INFORMATION

- The following module assembly sequence must be observed!
- The illustrations may differ depending on the connection terminals used!

- If this has not yet been done, press the bus connector (JanBus interface) included in the scope of delivery into the sockets on the rear of your module.

**ATTENTION**

**Improper handling may cause damage to the module and result in material damage!**  
 The contacts of the bus connectors (JanBus interface) can bend or break off and destroy the bus connector.

- **Never touch or manipulate the contacts of the bus connector!**
- **Never force the bus connector into the module!**
- **When handling, transporting and storing the module, protect the contacts of the bus connector!**

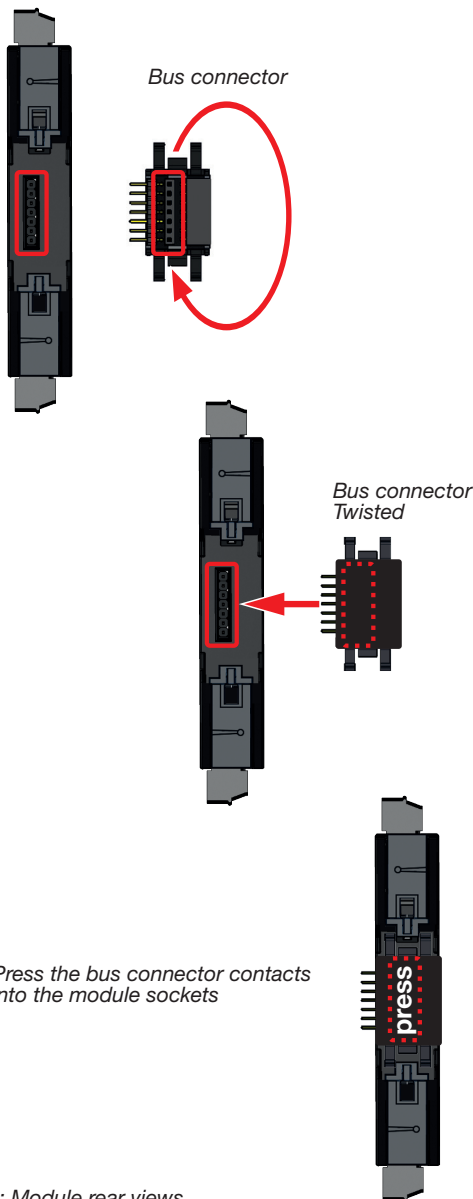

Fig.: Module rear views

- Press the module with the bus connector onto the DIN rail (for suitable DIN rail types, see Sect. "13. Technical data" on p. 35) until the bottom bolts engage (click).

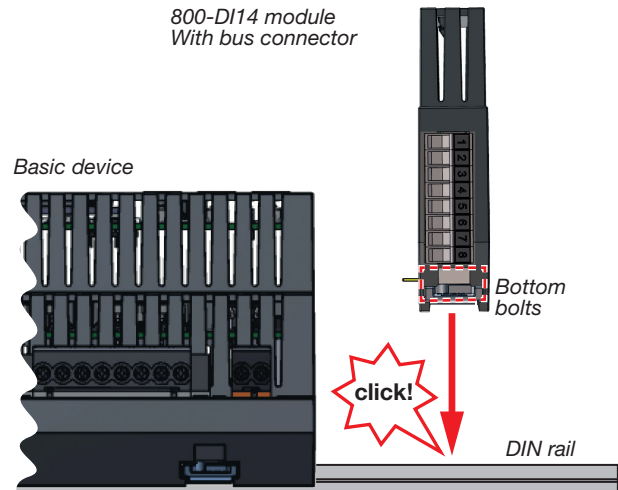

Fig.: Side view of basic device and 800-DI14 module

- To couple the bus connectors (devices), push the contacts of your module bus connector into the sockets of the basic device bus connector (or into the sockets of the connected module).

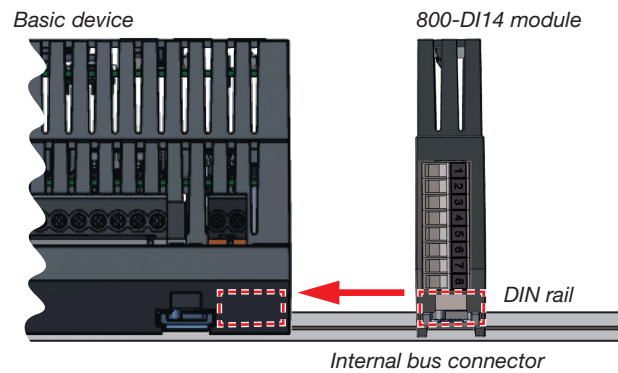

Fig.: Side view of basic device and 800-DI14 module



Fig.: Front view of a basic device with coupled 800-DI14 module  
(Mounting example - view without terminals)

5. After successfully coupling the bus connectors (of the devices), mount end brackets to the series of meters and modules.
6. Wire the module and apply power to the basic device (your system).  
The basic device automatically recognizes the module during the power-up procedure!

### **i** INFORMATION

Please note the following for the setup and dimensioning of your measurement device and module topology:

- 1 module of the type 800-DI14 has 14 digital inputs.
- The maximum bus length of the JanBus can be found in Sect. "13. Technical data" on p. 35
- Use end brackets to set up your measurement device and module series on the DIN rails.

## 4.2 Checking the module's communication

After installing your module, check the function of the communication between the basic device and the module using the display on the basic device (e.g. a UMG 801) as follows:

- When you are in the *Home* measuring display of the basic device, pressing the button 1 *ESC* takes you to the *Menu* window.
- Use buttons 2 (5) and 5 (6) to select the menu item *System information* and confirm with button 3 *Enter*.
- The *System information* window with the items *Basic device* and *Module 1* appears.

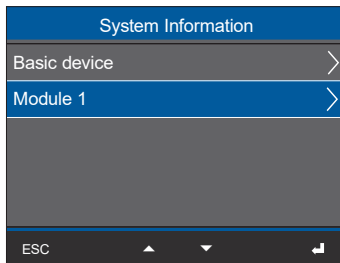

Fig.: System information window of a basic device with the entries "Basic device" and "Module 1".

- The basic device has detected module 1.

## 4.3 Faulty module communication

Error after starting the basic device with module:

### **i** INFORMATION

**The basic device does not recognize modules during the power-up procedure!**

If there is no communication to modules, the module functions are not supported (e.g. current measurements).

- **Disconnect your system from the power supply and check the condition of the bus connectors and the connections of your modules to the basic device (JanBus interface). If necessary, push the contacts of the module bus connectors into the sockets of the basic device bus connector or the attached modules so that the bus connectors (devices) are coupled.**
- **For remote module series, check the connection of the transfer modules.**
- **If necessary, restart the basic device.**
- **If these measures do not lead to the desired result, please contact our Support – [www.janitza.com](http://www.janitza.com).**

### 5. Connections/controls

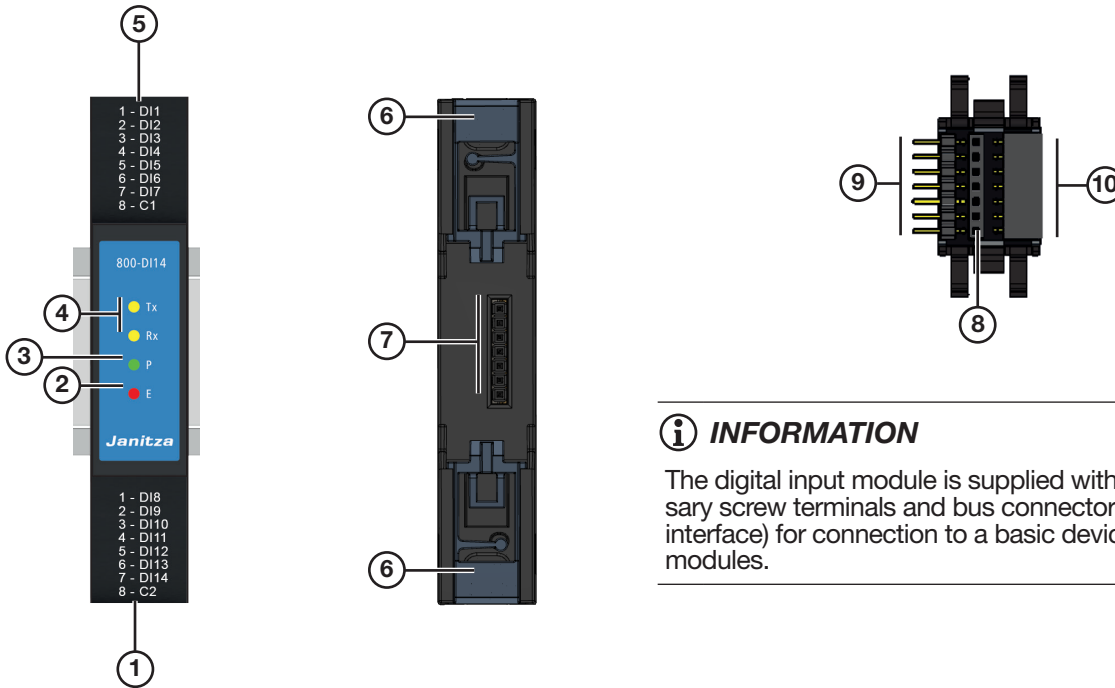

**i INFORMATION**

The digital input module is supplied with the necessary screw terminals and bus connectors (JanBus interface) for connection to a basic device or other modules.

Item	Designation	Description
1	Connections, 8-pin	Digital inputs (bottom of module).
2	LED (E ... Error)	Lights "red" during initialization/startup and in the event of a fault (error). Take note in this regard of Sect. "15.2 Modules - Error cases" on p. 39.
3	LED (P ... Power)	Lights "green" if the supply of power via the JanBus interface of the basic device is correct; the device is ready for operation.
4	2 LEDs (Tx ... Transmit data, Rx ... Receive data)	Blink "orange" during operation and indicate cyclic data exchange.
5	Connections, 8-pin	Digital inputs (top of module).
6	Bottom bolts	For mounting the module on the DIN rail.
7	JanBus interface - rear of module	Connection contacts for the communication bus connector (item 8).
8	Communication bus connector - JanBus interface	Bus connector insert (sockets) into the module
9	Communication bus connector - JanBus interface	Connection to a basic device (or connected modules).
10	Communication bus connector - Bus connector contacts (JanBus)	Connection of additional modules.

### 6. Module markings – rating plate

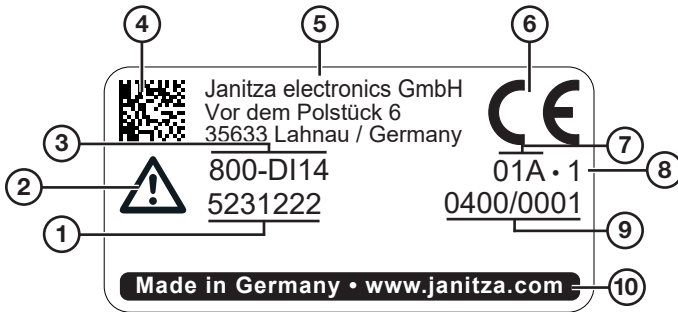

Item	Designation	Description
1	Part number	Marking for traceability.
2	Symbol for "Danger sign"	General hazard symbol. Be certain to observe the warning notices applied to the device and shown in the documentation in order to avoid possible injury or even death.
3	Device description (identification)	Device designation (model, device type).
4	DataMatrix code	Coded manufacturer data.
5	Manufacturer	Complete contact address of the manufacturer (company name, street, house number, postal code, city, country).
6	CE conformity marking	See Sect. "3.5 EU/UKCA Declaration of Conformity" on p. 16.
7	Manufacturer-specific data	Manufacturer data
8	Hardware version	Hardware version of the module
9	Type/serial number	Number for identification of the device
10	Designation of origin/web address	Country of origin and manufacturer's web address

## 7. Installation

### **⚠ WARNING**

**Risk of injury due to high currents and high electrical voltages!**

Severe bodily injury or death can result from:

- Touching bare or stripped leads that are energized.
- Inputs of devices, components and modules are dangerous to touch.

Therefore, please note for your system:

- **Disconnect the supply of power before starting work!**
- **Secure it against being switched on!**
- **Check to be sure it is de-energized!**
- **Ground and short circuit! Use the ground connection points with the ground symbol for grounding!**
- **Cover or block off adjacent live parts!**

### 7.1 Digital inputs

The 800-DI14 digital input module extends the functional range of a basic device by an additional 14 digital inputs.

When connected to a basic device, the digital inputs of your 800-DI14 module receive information from other devices with digital outputs (pulse generators).

The digital inputs detect an input signal at a voltage of at least 18 V and at most 28 V DC (typically at 4 mA) or a current of at least 0.5 mA and at most 6 mA.

For voltages from 0 to 5 V and currents less than 0.5 mA there is no input signal.

### **i INFORMATION**

- Observe the polarity of the supply voltage and the order of the connections "1-8" of the plug-in terminals during installation!
- The device and module illustrations may vary depending on the basic device and connection terminals used!

### **ATTENTION**

**Transmission error and material damage due to electrical malfunction.**

With a cable length of more than 30 m, there is an increased probability of transmission errors and damage to the device due to atmospheric discharge!

**Use shielded cables for the connections to the digital inputs and outputs!**

Digital inputs on the top of the module

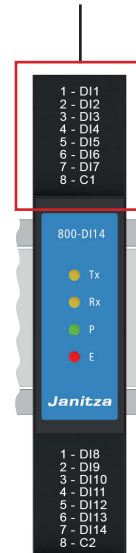

Pulse generator for switching the digital inputs

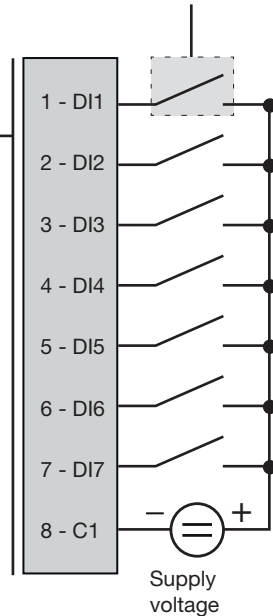

Supply voltage

Pulse generator for switching the digital inputs



Digital inputs on the bottom of the module

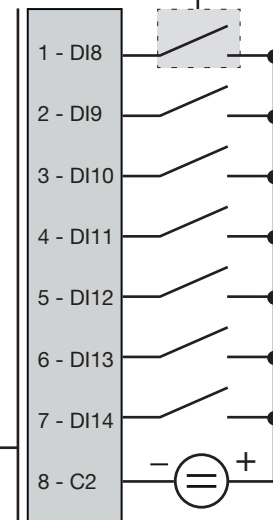

Supply voltage

### **i INFORMATION**

- Details on measurement displays for the digital input module and the digital inputs can be found in Sect. "11. Module-relevant measuring displays (800-DI14 module only)" on p. 32.
- You can configure the functions of the digital inputs easily and clearly in the GridVis software (see [www.janitza.com](http://www.janitza.com)).

### 7.2 Startup procedure/initialization

Modules started on a basic device (e.g. current measuring modules or digital input modules) trigger a blink interval of the LEDs. The blink interval of the LEDs and the meaning can be found in Sect. 7.4.3 on p. 27

### 7.3 Connection example

#### 800-DI14 module

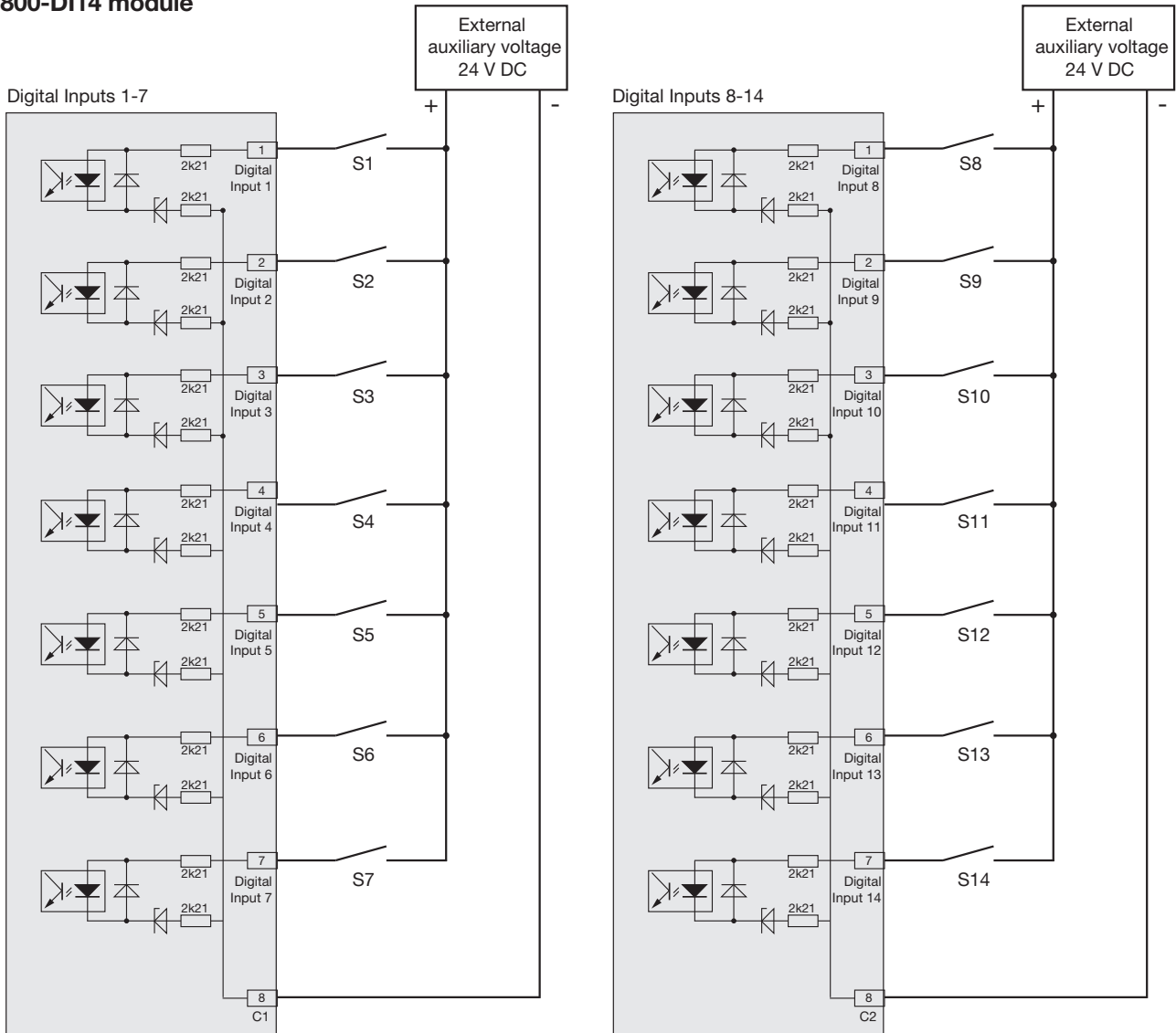

Fig. Connection example of external switching contacts S1 - S7 and S8 - S14 to the digital inputs of the 800-DI14 module

## 7.4 Module identification / Diagnostics on the basic device

### **i** INFORMATION

Before you start the module identification function (*Diagnostics* menu item) on the basic device, please make sure that the modules are mounted and connected correctly. Only correctly installed modules connected to the basic device guarantee the supply of power and data transmission.

The following descriptions are based on the example of the UMG 801 as the basic device. The illustrations and descriptions may differ for other basic devices.

The basic device has the option of extending the range of functions using digital input modules. The basic device automatically recognizes the module during the power-up procedure.

The Diagnostics menu item of the basic device is used to identify modules that are located at remote measurement points. After starting the module identification, the LEDs of the modules being searched for blink at an interval (see section „7.4.3 Module identification - LED blink interval“ on page 27).

The module identification can be configured via the *Diagnostics* menu item of the basic device. Then proceed as follows:

- Press function button 1 *ESC* to open the menu.
- Use buttons 2 “▲” and 5 “▼” to select the menu item *Diagnostics* and confirm with button 3 *Enter*.
- The *Diagnostics* window appears.

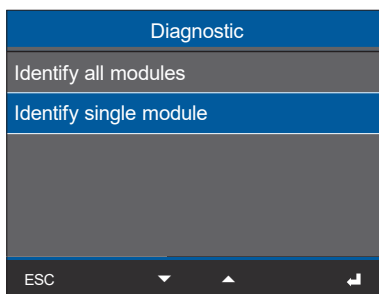

Fig. Window: Diagnostics with entries

- In the *Diagnostics* window, use keys 2 “▲” and 5 “▼” to select the entry *Identify all modules* or *Identify one module*. These mean:

<b>Identify all modules</b>	Simultaneously identifies <b>all</b> current measuring modules connected to a basic device.
<b>Identify one module</b>	Identifies <b>one</b> module from the module topology of your basic device.

### 7.4.1 Entry Identify all modules

- In the *Diagnostics* window, use buttons 2 “▲” and 5 “▼” to select the menu item *Identify all modules* and confirm with button 3 *Enter*.
- The window *Identify all modules* appears.

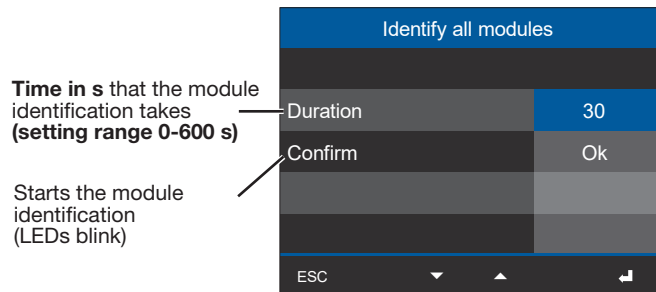

Fig. Window, Identify all modules

- In the *Identify all modules* window, use buttons 2 “▲” and 5 “▼” to select the menu item *Duration* and confirm with button 3 *Enter*.
- The first digit of the entry *Duration* blinks.
- Use buttons 4 (◀) and 6 (▶) to change the position of the digit to be set and buttons 2 (▲) and 5 (▼) to change the digit (-1/+1).
- Confirm your entries with key 3 *Enter*.
- Use keys 1 *ESC* and key 5 “▼” to access the entry *Confirm*.
- Press button 3 *Enter*.
- In the entry *Confirm*, *OK* blinks.
- Pressing key 3 *Enter* starts the identification of all modules using a blink interval of the LEDs (see section „7.4.3 Module identification - LED blink interval“ on page 27).

### 7.4.2 Entry Identify one module

- In the *Diagnostics* window, use buttons 2 “▲” and 5 “▼” to select the menu item *Identify one module* and confirm with button 3 *Enter*.
- The *Identify one module* window appears.

Position of the module in the order of the basic device's module topology.

Time in s that the module identification takes (setting range 0-600 s)

Starts the module identification (LEDs blink)

Identify single module	
Module position	1
Duration	30
Confirm	Ok
ESC ▼ ▲ ↵	

Fig. Window: Identify one module

- In the *Identify one module* window, use keys 2 “▲” and 5 “▼” to select the menu item *Module position* and confirm with key 3 *Enter*.
- The entry *Module position* blinks.
- Use the keys 2 “▲” and 5 “▼” to enter the position number of the module to be identified (the position number depends on the number of modules connected in series to the basic device).
- Confirm the entry with key 3 *Enter*.
- Use keys 1 *ESC* and key 5 “▼” to access the entry *Duration*.
- Press button 3 *Enter*.
- The first digit of the entry *Duration* blinks.
- Use buttons 4 (◀) and 6 (▶) to change the position of the digit to be set and buttons 2 (▲) and 5 (▼) to change the digit (-1/+1).
- Confirm your entries with key 3 *Enter*.
- Use keys 1 *ESC* and key 5 “▼” to access the entry *Confirm*.
- Press button 3 *Enter*.
- In the entry *Confirm*, *OK* blinks.
- Pressing key 3 *Enter* starts the module identification with a blink interval of the LEDs on the corresponding module (see section „7.4.3 Module identification - LED blink interval“ on page 27).

### 7.4.3 Module identification - LED blink interval

The module identification (diagnostics) procedure started on the basic device triggers a blink interval of the LEDs on the digital input modules. The blink interval of the functions **Identify one module** and **Identify all modules** works the same way for a single module or for all modules!

### LED status of the module in operation:

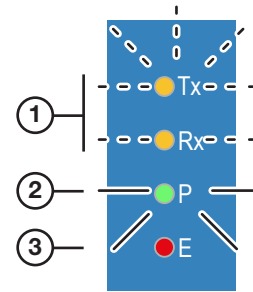

Item	Description
1	Blink "orange" during operation and signaling cyclic data exchange (Tx ... Transmit data, Rx ... Receive data).
2	Lights "green" if the supply of power via the JanBus interface of the basic device is correct, the device is ready for operation (P ... Power).
3	Lights "red" during initialization/startup and in the event of a fault (error). Note in this regard Sect. "15.2 Modules - Error cases" on p. 39.

### LED status of the module during module identification:

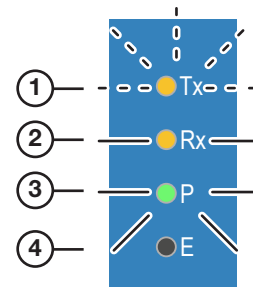

Item	Description
1	Blinks "orange" for the <i>Duration</i> of the module identification.
2	Lights "orange" for the <i>Duration</i> of the module identification.
3	Lights "green".
4	"Off"

### ⓘ INFORMATION

During the **Duration of individual module identification**, the blink intervals of all other modules connected to the basic device are paused!

## 8. Module communication / PC connection

### 8.1 Module communication

Configure the digital input modules using the display and the buttons on the basic device.

The basic device connected to your module or module series uses an integrated **Ethernet interface** for communication with a PC.

To configure or read out the basic device with module or with your module series, the PC must have the GridVis software installed.

Another option for configuring modules or reading out measured values may be available via the device homepage of the basic device.

#### **i** INFORMATION

Further information on PC connections can be found in the respective user manual for the basic device.

### 8.2 PC connection to the basic device with digital input module

The PC connections of the basic device or your module series via the Ethernet interface are shown below using the UMG 801 as an example for other basic devices.

#### 8.2.1 Connection to a DHCP server and PC

The DHCP server automatically assigns IP addresses to the basic device with module(s) and to the PC.

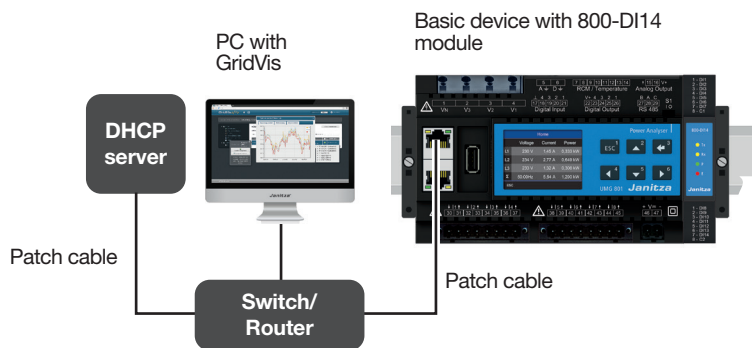

Fig. example: PC connection with DHCP server and PC

#### 8.2.2 Direct PC connection to the basic device with digital input module or your module series via the Ethernet interface

The PC and basic device require a fixed IP address.

PC with GridVis

Basic device with modules

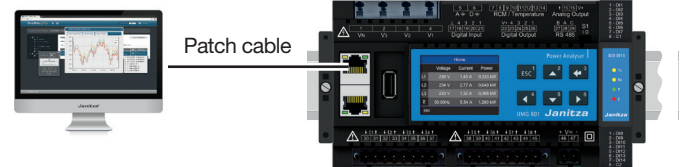

Fig. example: PC direct connection

**Detailed descriptions of connection via the Ethernet interface can be found in the user manual for the basic device.**

#### **i** INFORMATION

The figures described are examples! In conjunction with the basic device, there are numerous variants of topologies for devices and modules. Please refer to the usage information for the basic device and the modules of your devices and module topology.

### 8.3 Module communication options

#### 8.3.1 Module handling in the GridVis software

The interface of the GridVis power grid monitoring software indicates in graphical form the modules connected to the basic device.

A user can configure various types of module handling in the GridVis software, including:

- Automatic module recognition
- Module addition at the end of the module topology of a basic device.
- Module addition within the module topology of a basic device.
- Module removal at the end of the module topology of a basic device.
- Module removal within the module topology of a basic device.
- Module swap.
- Module configuration swap (measurement).
- Data storage and data transfer.
- Swap out basic device.

---

**A description of how to configure the modules in the GridVis software can be found in the online help or the tutorials for the software.**

---

#### 8.3.2 Basic device homepage

Another option for configuring modules or reading out measured values may be available via the device homepage of the basic device!

All further descriptions of a device homepage can be found in the usage information for the basic device.

## 9. Operation and display

### 9.1 Operation and button functions of the basic device with module 800-DI14

The basic device with module has a display and function buttons to enable installation, commissioning and configuration without a PC.

#### **i** INFORMATION

- The configuration of your module and the display of module-relevant measurement data is carried out via the basic device.
- Information on operation, the display and the button functions can be found in the usage information for the basic device.
- The **GridVis** network analysis software is available at [www.janitza.com](http://www.janitza.com) and can be used to configure your basic device with modules and read out data for analysis (prerequisite: PC connection to your basic device).

### 9.2 Module-relevant menu items of the basic device with one 800-DI14 module

The following illustrations and descriptions show module-relevant menu items in the measurement device display using the example of the UMG 801 as the basic device with the 800-DI14 modules.

The menu items in the measurement device display of the basic device

- include, for example with the UMG 801 as the basic device, up to 10 module entries with the respective position number, depending on the slot assignment. For additional basic devices, please refer to the maximum number of modules in „Tab. Suitable basic devices“ on p. 2.
- Can be configured with your own measurement group name in the GridVis software (max. 255 characters).
- Appear in the title line as scrolling text depending on the text length.

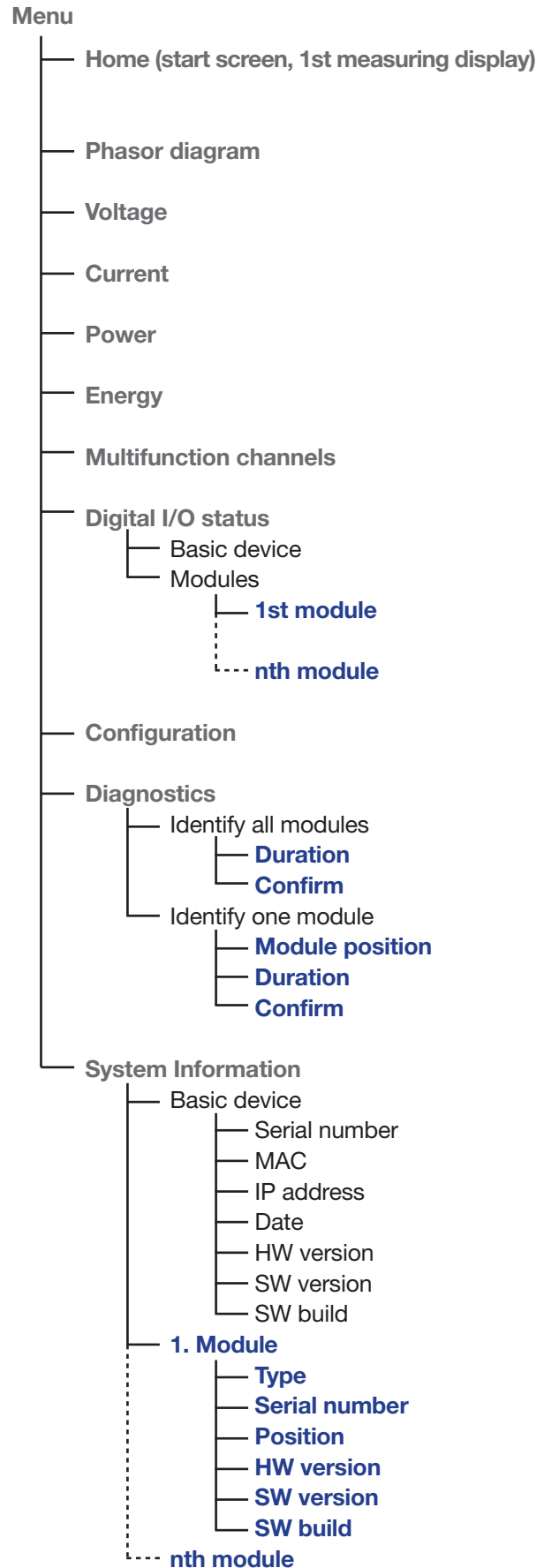

## 10. Status messages

Use the 14 digital inputs of the 800-DI14 module to send information from other devices with a digital output to your basic device.

The following descriptions are based on the example of the UMG 801 as the basic device. The illustrations and descriptions may differ for other basic devices.

Status messages of the digital inputs appear as follows on the basic device:

- Press function button 1 *ESC* to open the menu.
- Use buttons 2 "*▲*" and 5 "*▼*" to select the menu item *Digital I/O status* and confirm with button 3 *Enter*.
- The *Digital I/O status* window appears.

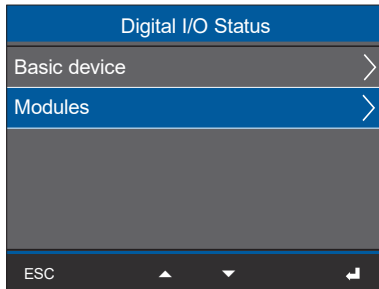

Fig. "Digital I/O status" window

- Use the *Digital I/O status* window with the buttons 2 "*▲*" and 5 "*▼*" to select the item *Digital I/O status, modules*.
- The *Digital I/O status, modules* window appears.

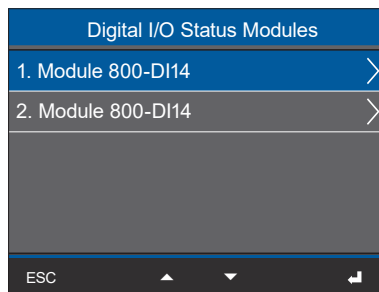

Fig. Example: "Digital I/O status module" window with two 800-DI14 modules

- Use the *Digital I/O status, modules* window with the buttons 2 "*▲*" and 5 "*▼*" to select the item *1st module 800-DI14 (digital input module 1)*.
- The window *1st 800-DI14 module* appears for the first item.

1. Module 800-DI14						
DI1	DI2	DI3	DI4	DI5	DI6	DI7
0	1	0	1	0	1	0
1	0	1	0	1	0	1
DI8	DI9	DI10	DI11	DI12	DI13	DI14
ESC						▶

Fig. Window of the 1st digital input module

The window *1st 800-DI14 module* shows the 14 digital inputs of the first module with the respective status message with the following meanings:

- 1 ... A signal is present at the respective input.
- 0 ... No signal is present.

The requirements for a digital input to have the status 0 or 1 can be found in the Sect. "13. Technical data" on p. 35.

### **i** INFORMATION

A list with the status messages of the digital inputs (basic device and digital input modules) can also be found on the device homepage of the basic device, if needed. Please refer to the usage information for your basic device!

## 11. Measuring displays

### **i** INFORMATION

The following module-relevant measuring and meter displays of the basic device with 800-DI14 module do not show a specific use case and may differ depending on the connection of your basic device with modules and the measuring environment.

- The permitted number of digital input modules on a basic device can be found in „Tab. Suitable basic devices“ on p. 2.
- You can change the names of the basic device, the modules or the measurement groups shown in the measurement device display using the device configuration of the GridVis software.
- The measurement device display shows the measurement group names with the respective position number of the module.
- Depending on the text length, measurement group names appear as scrolling text in the title line of the measurement device display.
- Further measured value and instrument displays can be found in the usage information for the basic device.

Menu (digital I/O status)

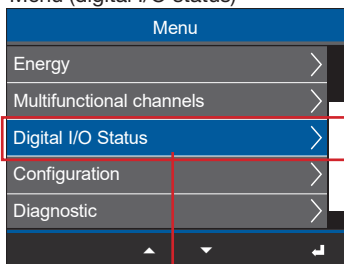

Digital I/O status submenu

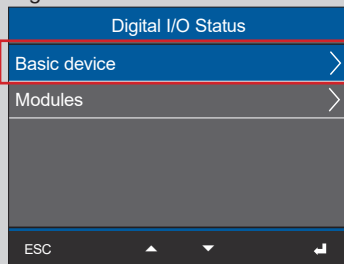

Digital I/O Status Basic device			
DI1	DI2	DI3	DI4
0	0	0	0
0	0	0	0
DO1	DO2	DO3	DO4
ESC			

*Display of status messages of the basic device digital inputs and outputs.*

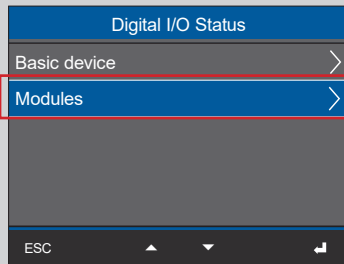

1. Module 800-DI14						
DI1	DI2	DI3	DI4	DI5	DI6	DI7
0	1	0	1	0	1	0
1	0	1	0	1	0	1
DI8	DI9	DI10	DI11	DI12	DI13	DI14
ESC						

*Display 1. Digital input module with status messages for 14 digital inputs.*

Menu (Configuration)

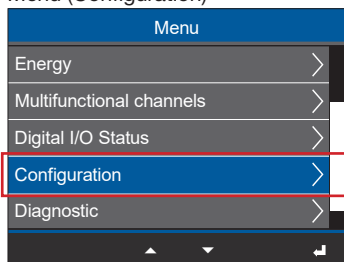

***i* INFORMATION**

**Information on configuration (basic device with modules) can be found in the user manual for the basic device.**

Menu (Diagnostics)

Menu	
Multifunctional channels	>
Digital I/O Status	>
Configuration	>
<b>Diagnostic</b>	>
System Information	>
ESC	▲ ▼ ▾ ▹

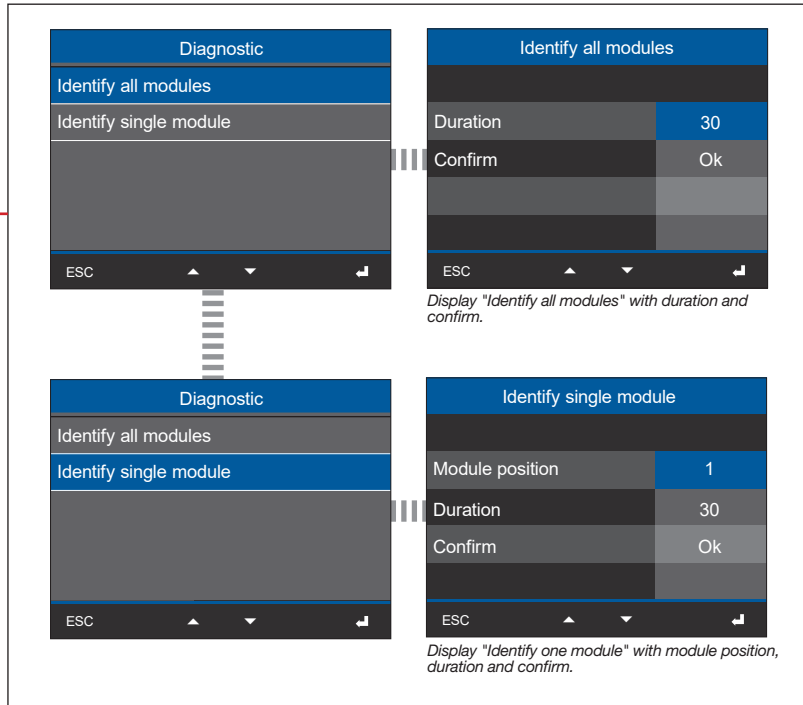

Menu (System information)

Menu	
Multifunctional channels	>
Digital I/O Status	>
Configuration	>
Diagnostic	>
<b>System Information</b>	>
ESC	▲ ▼ ▾ ▹

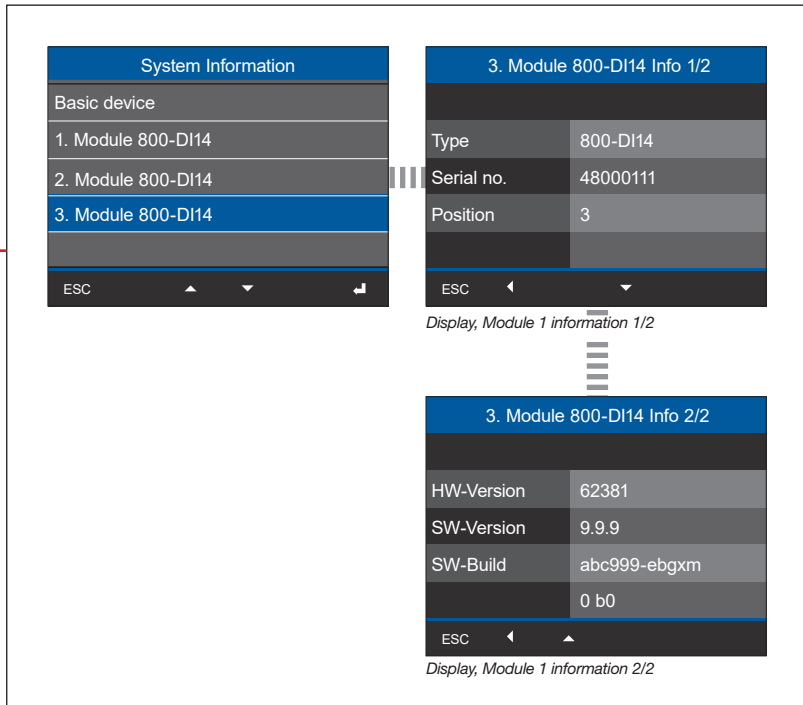

## 12. Device views

- The views are for illustration purposes only and are not to scale.
- Dimensions in mm (in).

Front view

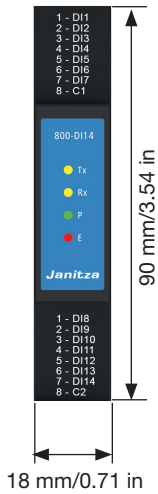

**i INFORMATION**

The dimensions of the device/module vary depending on the connection terminals used!

Bottom view



Top view



View from left

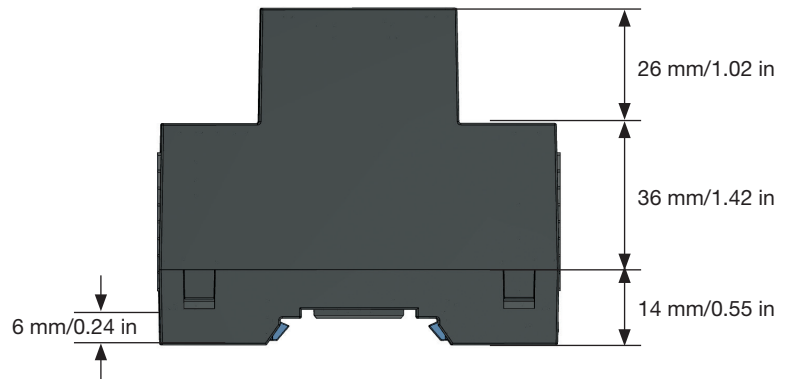

Rear view



Connector for the bus connector

Communication bus connector to the 800-DI14 module

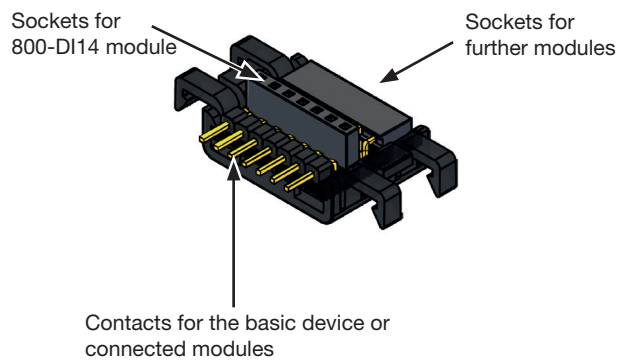

### 13. Technical data

General	
Net weight (with terminals)	73 g (0.16 lb)
Device dimensions (without connection terminals)	W = 18 mm (w = 0.71 in), H = 90 mm (h = 3.54 in), D = 76 mm (d = 2.99 in)
Width of the device in horizontal pitches	1 HP (1 HP = 18 mm)
Mounting orientation	As desired
Fastening/mounting - Suitable DIN rails - (35 mm / 1.38 in)	TS 35/7.5 according to EN 60715 TS 35/10 TS 35/15 x 1.5
Protection against foreign matter and water	IP20 according to EN60529
Impact resistance	IK07 according to IEC 62262

Transport and storage	
The following specifications apply for devices transported and stored in the original packaging.	
Free fall	1 m (39.37 in)
Temperature	K55 - -25 °C (-13 °F) to +70 °C (158 °F)
Relative humidity	0 to 95% at 25 °C (77 °F), no condensation

Environmental conditions during operation	
The module · Must only be operated with suitable basic devices (see „Tab. Suitable basic devices“ on p. 2. · Is for weather-protected and stationary use. · Fulfills operating conditions according to DIN IEC 60721-3-3. · Has protection class II according to IEC 60536 (VDE 0106, part 1), a ground wire connection is not required!	
Working temperature	-10 °C (14 °F) .. +55 °C (131 °F)
Relative humidity	5 to 95% at 25 °C (77 °F), no condensation
Pollution degree	2
Ventilation	No forced ventilation required.
Supply voltage	Via basic device

Digital inputs	
14 digital inputs, solid state relays, not short-circuit proof.	
Maximum counter frequency	20 Hz
Input signal applied	18 .. 28 V DC (typically 4 mA)
Input signal not applied	0 .. 5 V DC, current less than 0.5 mA

Interface and energy supply	
JanBus (proprietary)	Via bus connector Max. bus length (JanBus) 100 m.
Supply voltage (via JanBus interface)	24 V

<b>Connection capacity of the terminals - Spring terminals (push-in terminals)</b>	
Connectible conductors. Only connect one conductor per terminal point!	
Single core, multi-core, fine-stranded (min. - max.)	0.14 mm <sup>2</sup> - 1.5 mm <sup>2</sup> , AWG 26-16
Wire ferrules with collar * to DIN 46 228/4, (min. - max.)	0.25 mm <sup>2</sup> - 1 mm <sup>2</sup> , AWG 22-17
Wire ferrules without collar to DIN 46 228/1, (min. - max.)	0.25 mm <sup>2</sup> - 1.5 mm <sup>2</sup> , AWG 22-16
Wire ferrules: - Contact sleeve length ** - Strip length	- 8 - 12 mm (0.31 - 0.47 in) - 10 - 12 mm (0.39 - 0.47 in)

\* ... Applies to wire ferrules with a maximum plastic collar outer diameter of up to 3.5 mm (0.14 in).

\*\*.. Depending on the type of wire ferrules used (wire ferrules manufacturer).

<b>LEDs</b>	
Tx (send data)	Blink "orange" during operation and indicate cyclic data exchange.
Rx (receive data)	
P (power – power supply)	Lights "green" if the supply of power via the JanBus interface is correct.
E (error – initialization and malfunction)	Lights "red" when initializing/starting the device and in the event of a fault.

### **INFORMATION**

Detailed information on the functions and data of the basic device can be found in the usage information included with the basic device or available for download at [www.janitza.com](http://www.janitza.com)!

## 14. Dismounting

### ATTENTION

**Handling your module too roughly may cause damage to the module and result in material damage!**

The bus connector contacts and the bottom bolts can be damaged or broken off when dismantling your module.

- **Never pull the module out of the DIN rail forcefully.**
- **First decouple the bus connectors (JanBus interface) and carefully unlock the bottom bolts of the module with a screwdriver!**

### ATTENTION

**Material damage due to disassembly or decoupling of the module during operation!**

Dismounting or decoupling the module during communication with the basic device can cause damage to your devices!

- **Disconnect your system from the power supply prior to dismantling or disconnecting the module! Secure it against being switched back on! Check to be sure it is de-energized! Ground and short circuit! Cover or block off adjacent live parts!**

1. Disconnect the supply of power to the system! Secure it against being switched on! Check to be sure it is de-energized! Ground and short circuit! Cover or block off adjacent live parts!
2. Disconnect the wiring of your module.
3. Decouple the bus connectors (JanBus interface) of your module from the basic device and/or the connected modules by pulling out your module.
4. Unlock all bottom bolts of your module  
**Recommendation:** Use a screwdriver (be careful!).
5. Remove your module from the DIN rail without touching or damaging the bus connector contacts.

### **i** INFORMATION

**Observe the following:**

**After dismantling the 800-DI14 module, the GridVis software deactivates the corresponding module!**

Information on this and further procedures can be found in the online help for the GridVis software.

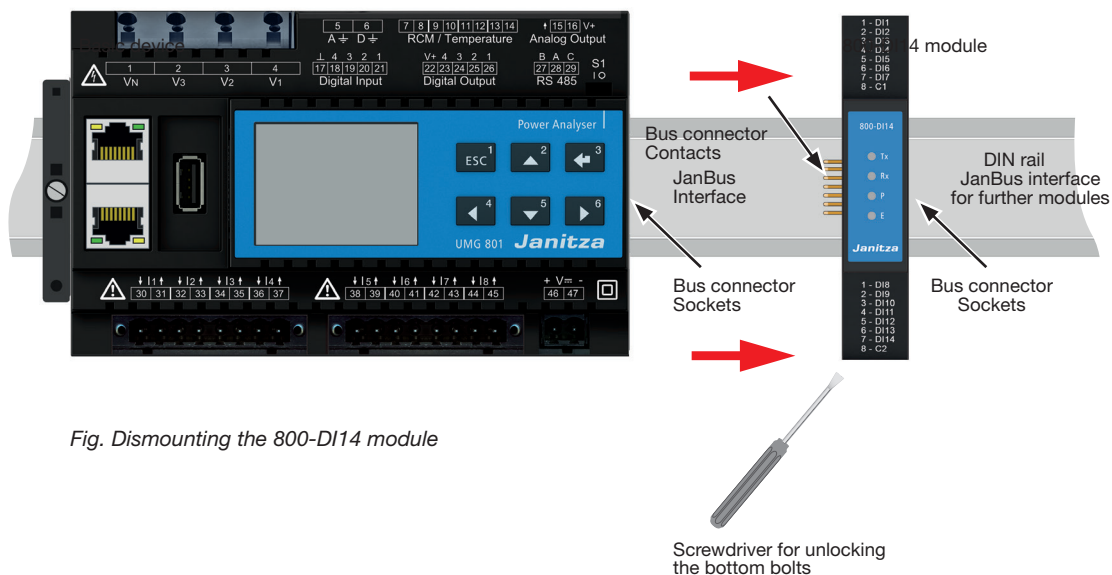

Fig. Dismounting the 800-DI14 module

## 15. Module exchange/error cases

Before replacing a module, please refer to Sect. "14. Dismounting" on p. 37 and „4. Mounting“ on p. 18.

### ATTENTION

**Handling your module too roughly may cause damage to the module and result in material damage!**

The bottom bolts and the bus connector contacts can be damaged or broken off when dismantling your module.

- **Never pull the module out of the DIN rail forcefully.**
- **Remove the module from the DIN rail without touching or damaging the bus connector contacts.**
- **First remove the connection terminals with the wiring and then carefully unlock the bottom bolts of the module with a screwdriver!**

### ATTENTION

**Material damage due to disassembly or decoupling of the modules during operation!**

Dismounting or decoupling the modules during communication with the basic device can cause damage to your devices!

- **Disconnect your system from the power supply prior to dismantling or decoupling the modules! Secure it against being switched back on! Check to be sure it is de-energized! Ground and short circuit! Cover or block off adjacent live parts!**

### INFORMATION

**Observe the following:**

**After dismantling modules, the GridVis software deactivates the corresponding module!** Information on this and further procedures can be found in the online help for the GridVis software.

### 15.1 Module replacement

A module must be exchanged, for example to replace a defective module with an intact module in your meter and module topology. The module replacement is carried out in the GridVis software.

**On the basic device**, you can recognize a defective module of your measurement device and module topology in the "Configuration" display. The defective module is **missing** in the "Configuration" display.

1. Remove the corresponding module as described in Sect. "14. Dismounting" on p. 37.
2. Replace a defective module, for example, with an intact one (see Sect. "4. Mounting" on p. 18).
3. Supply your meter and module topology (your system) with voltage.
4. Use the GridVis software ("Module exchange" function) to transfer data from a defective module (stored in the basic device) to the intact module.

### INFORMATION

Please note before replacing a module! The "Module exchange" function in the GridVis software overwrites data records of exchanged modules in the memory of the basic device!

A description of the module exchange in the GridVis software can be found in the online help or the tutorials for the software.

### 15.2 Modules - Error cases

As already described in Sect. “7.4.3 Module identification - LED blink interval” on p. 27, the module has 4 LEDs.

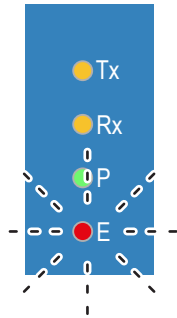

In the event of an error, the red LED (E) of the module blinks during operation at an interval of **0.5 s**.

After the definition of the error state there is a pause of **2 s** and the blink interval starts again from the beginning (repetition loop).

The number of blinks indicates the following error states:

Number of blinks	Error state
0	No error - normal operation.
1	Waiting for termination of the start pulse for the termination.
2	Waiting for response of the following module.
3	Waiting for start of addressing pulse
4	Waiting for the end of the addressing pulse.
5	Termination failed.
10	Application could not be started, module is still in the bootloader.

Tab.: Allocation of blink intervals/error state

### Proceed as follows in the event of a module error:

1. Restart your meter and module topology (basic device: Menu > Configuration > System > Restart).
2. Check the connections and the fit of the devices, modules and components of your meter and module topology while complying with the safety rules!

**⚠ WARNING**

**Risk of injury due to electrical current and voltage!** Severe bodily injury or death can result! Therefore please abide by the following:

- **Do not touch bare, stripped wires or device inputs that are dangerous to touch on the devices, components and modules.**
- **Switch off your installation before commencing work! Secure it against being switched on! Check to be sure it is de-energized! Ground and short circuit! Cover or block off adjacent live parts!**

3. If these measures are unsuccessful, please contact our support team ([www.janitza.com](http://www.janitza.com))!

## 16. Service and maintenance

Prior to outbound delivery, your device (component/module) is subjected to various safety tests and is marked with a seal. If the device (component/module) is opened, the safety tests must be repeated. The warranty is only valid for unopened devices (components/modules).

### 16.1 Repair

Repairs can only be carried out by the manufacturer.

### 16.2 Service

If questions arise which are not described in this user manual, please contact the manufacturer.

To answer your questions, it is essential that you provide the following information:

- Device designation (see rating plate).
- Serial number (see rating plate).
- Hardware version (see system display).
- Software release (see system display).
- Measured voltage and supply voltage.
- An exact error description.

### 16.3 Device adjustment

Devices (components/modules) are adjusted by the manufacturer prior to outbound delivery. No readjustment is required when the environmental conditions are complied with.

### 16.4 Calibration interval

A recalibration is recommended after about 5 years. Contact the manufacturer or an accredited laboratory for calibration.

### 16.5 Firmware update

A firmware update of the basic device and the module can be done

4. via the device homepage of the basic device (menu "Settings -> Firmware update" - see usage information for the basic device).
5. via the firmware update wizard of the GridVis software:
  - Open the Firmware Update Assistant in the GridVis software by clicking "Update device" in the "Extras" menu.
  - Select a corresponding update file and carry out the update

### INFORMATION

This user manual describes the modules and provides information on the operation of the modules via the basic device.

In addition to this user manual, refer to the usage information for your basic device, such as:

- User manual
- Installation manual
- Safety information
- Data sheet
- Installation supplement

In addition, also note any special usage information for your application/project!

Moreover, the **GridVis** software has an "online help" feature.

### 16.6 Procedure in the event of a malfunction

#### **ATTENTION**

##### **An error in the communication with the basic device leads to a device fault!**

If communication from the basic device to the modules is lacking or faulty during operation, a warning signal will appear on the display of the basic device.

##### **Prior to dismantling or disconnecting the modules of the basic device (the system)**

- **Disconnect the supply of power! Secure it against being switched on! Check to be sure it is de-energized! Ground and short circuit! Cover or block off adjacent live parts!**
- **Prior to remounting, it may be necessary to restart the basic device.**
- **Also take note of the chapter "Procedure in the event of a malfunction" in the documentation of your basic device.**
- **If the measures indicated here are unsuccessful, please contact our support team ([www.janitza.com](http://www.janitza.com)).**
- **If there is discernible damage, send the device, component or module back to the manufacturer in compliance with proper transport conditions.**

### 16.7 Reset to factory settings

The "Reset to factory settings" function must be carried out via the basic device. A description

of this can be found in the user manual for the basic device.

## 16.8 Information on saving measured values and configuration data

---

### **INFORMATION**

The basic device stores the following measured values every 5 minutes at the latest:

- S0 meter readings
- Min. / max. / average values
- Energy values (work values)

The basic device saves configuration data immediately!

---





# ***Janitza***

Janitza electronics GmbH  
Vor dem Polstück 6 | 35633 Lahnau  
Germany

Tel. +49 6441 9642-0  
info@janitza.com | www.janitza.com